

Cold-start calibration HFR500 fast FID

Accurate 'real-time' HC mass emissions
without a CVS tunnel....

Contents

- Introduction
- Fast FID basics
- Emissions analysis
 - Exhaust mass flow calculation
 - HC mass flow calculation
 - Wet/ dry compensation
- Case study
- Interpretation of data
- Catalyst warm-up
- Cold start optimisation principles
- Opportunities to improve calibration
 - Variables/ actuators
 - ECU strategy/ operation modes
 - Limitations
 - Tolerance/ variability
- Conclusions

Introduction - Rationale

- Why do we need fast emissions analysis for cold start ?
 - In order to study the effects of transient events
 - To understand the combustion, exhaust port and catalyst processes
 - To quantify the effect of individual events
 - To prioritise calibration effort towards problem areas
- In order to provide the associated **mass flow** data
 - Data must be measured directly from the exhaust system (engine-out, after catalyst, preserving transient features)
 - Exhaust mass flow rate, and HC are changing rapidly
 - Both of these parameters are required in order to calculate HC mass flow



Introduction – Instrumentation/ data

- Introduction to the instrumentation and data to be recorded

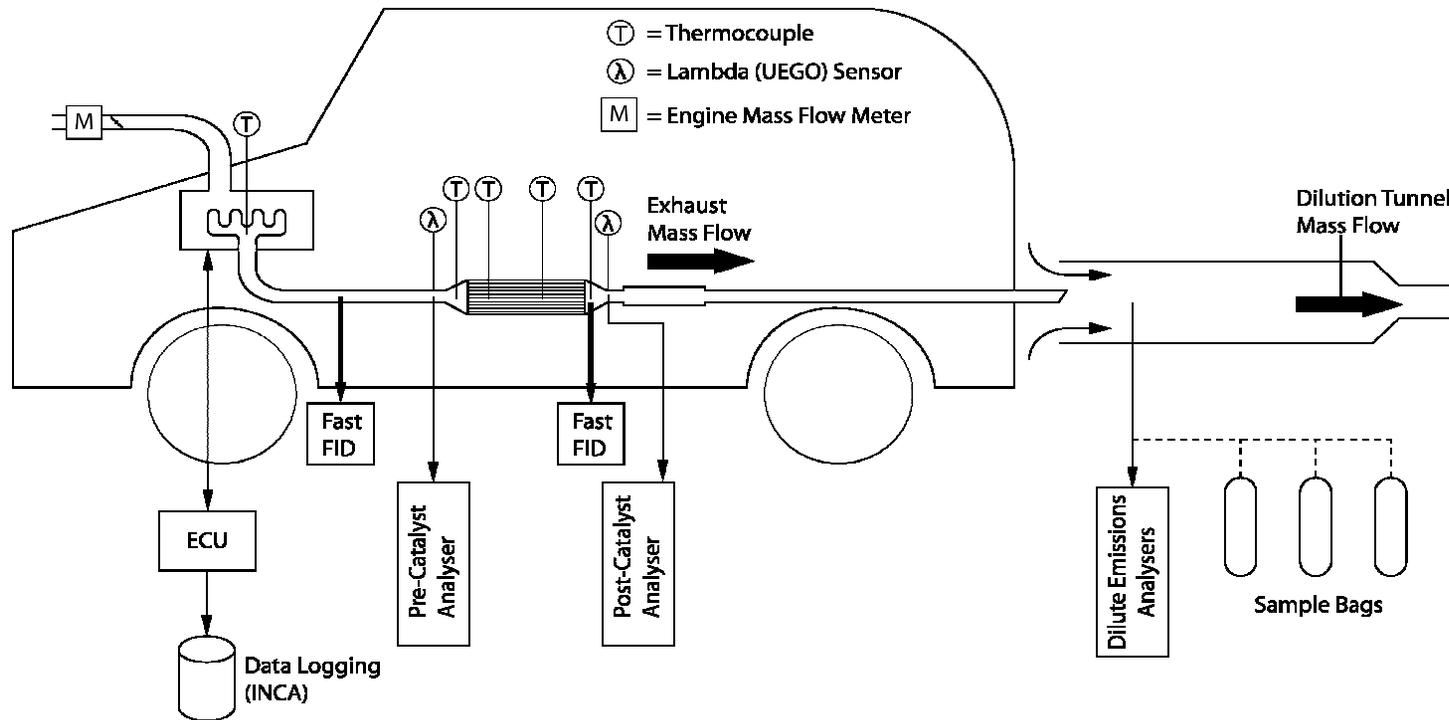

- Emissions are recorded with two different methods:
 - Exhaust gas measurements from inside the vehicle exhaust system ('raw' or 'direct')
 - For comparison, measurements from the diluted exhaust gas in the CVS tunnel ('dilute')

Introduction – Concentration and mass

- Important parameters
 - **Gas concentrations** from Emissions analysers

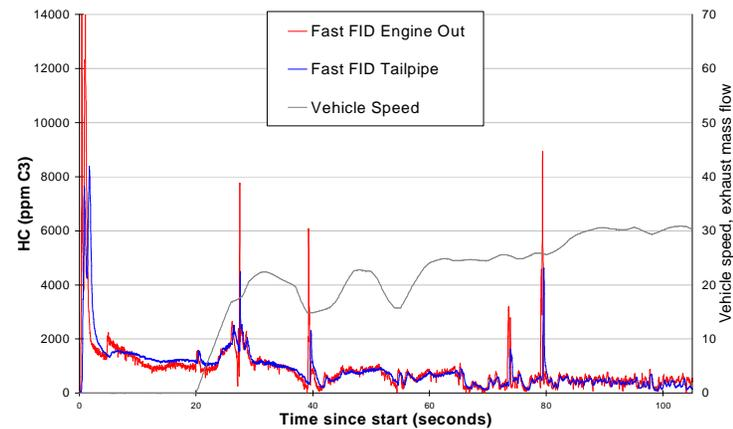

- The fundamental measure of pollutants as a fraction of the exhaust gas
- **Mass flow rate** of exhaust gas
 - This is needed to convert **concentration** to **mass**, from parts per million (**ppm**) or percent (%) to grams (**g**) for pollutants

HC concentration measurement with the Fast FID

- Pre and post cat sample location
- Maintenance
- 'Good practice'



Sample point selection criteria

For general cold-start application we need:

- **'Representative' HC concentrations**
 - Gas should be representative of the 'average' mixture
 - We should use a location in the pipe for a mixed sample (not sample from a particular area of catalyst)
 - Turbo can be helpful to mix the gas
- **'Representative' Exhaust mass flow**
 - For example, the flow in the exhaust port is pulsating faster than the engine air meter can measure. If this is the case, (HC x flow rate) calculation does not work, even if number of cylinders is accounted for....
 - Post cat in the pipe is suitable.
- **Point measurements can be useful.....**
 - For example to investigate the performance across the catalyst due to poor flow distribution
 - For case studies see SAE papers 2004-01-1489 and 2005-01-1095

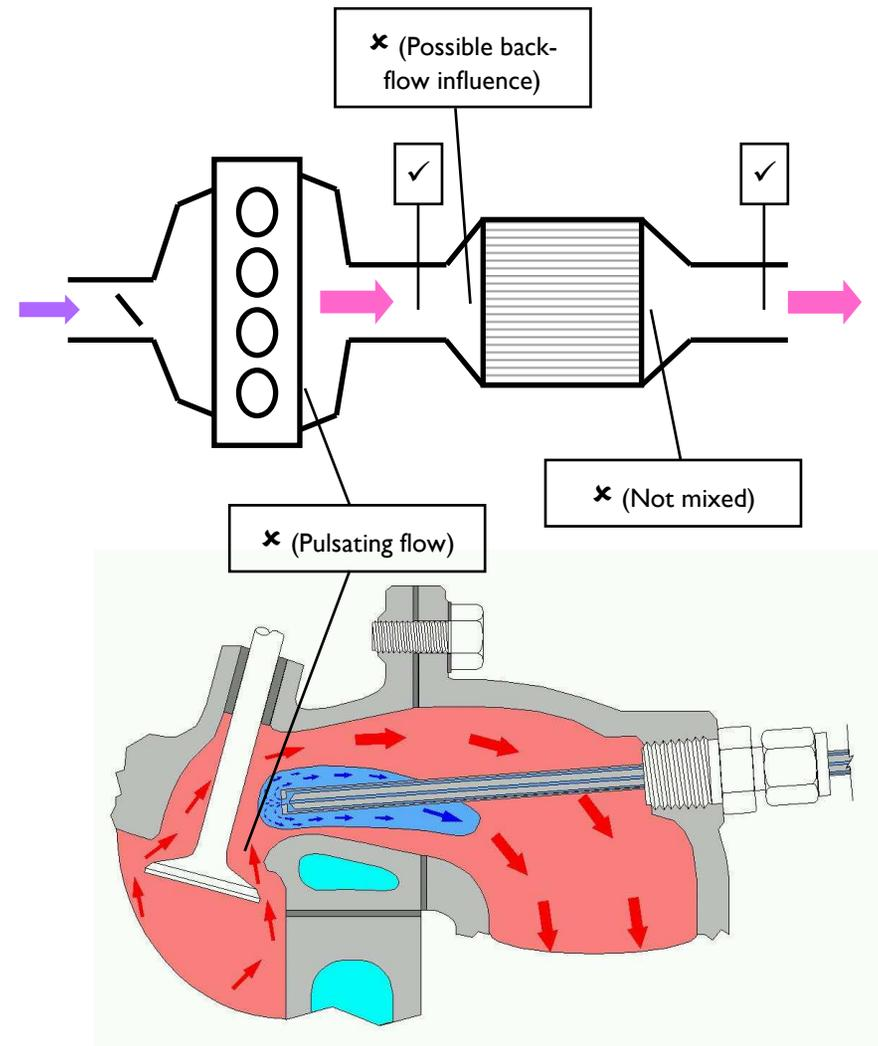

Fast FID basics - Maintenance

Daily recommended maintenance

- Daily check & cleaning while cold, sample line can be removed for cleaning
- Check of 'head gain' indicates correct operation – should be repeatable and close to a value of 1, high numbers indicate the sample system may be blocked
- Review of pre-requisites for good experimental practice
 - Span & zero checks before and after testing
 - Dynamic calibration (leak check)
 - Linearity check done
 - Comparison with bench analyser readings
 - Look at maintenance manual

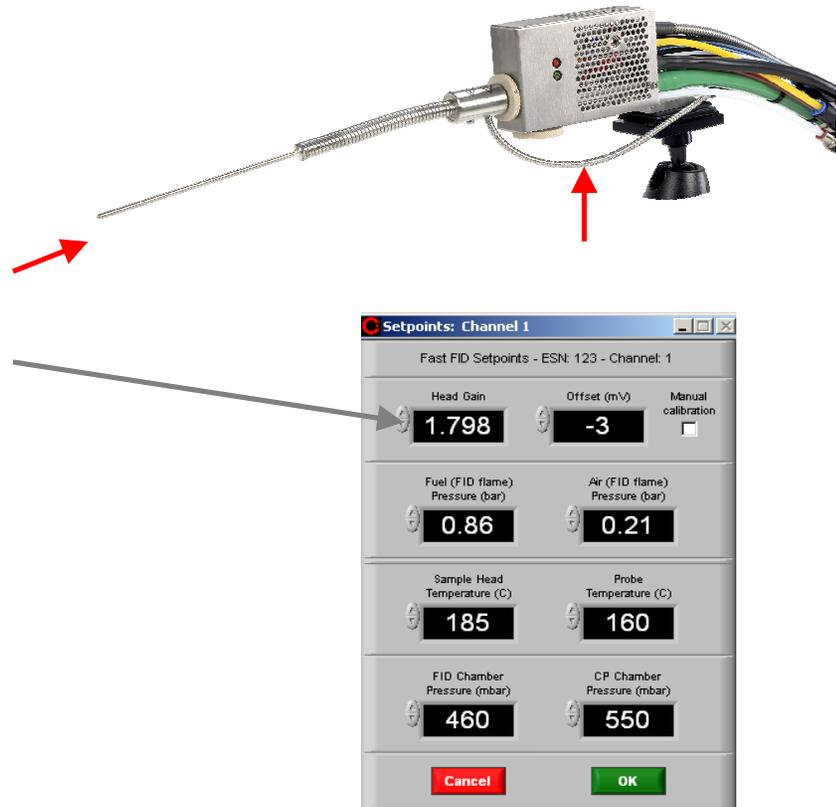

Exhaust mass flow (intake air flow + fuel flow)

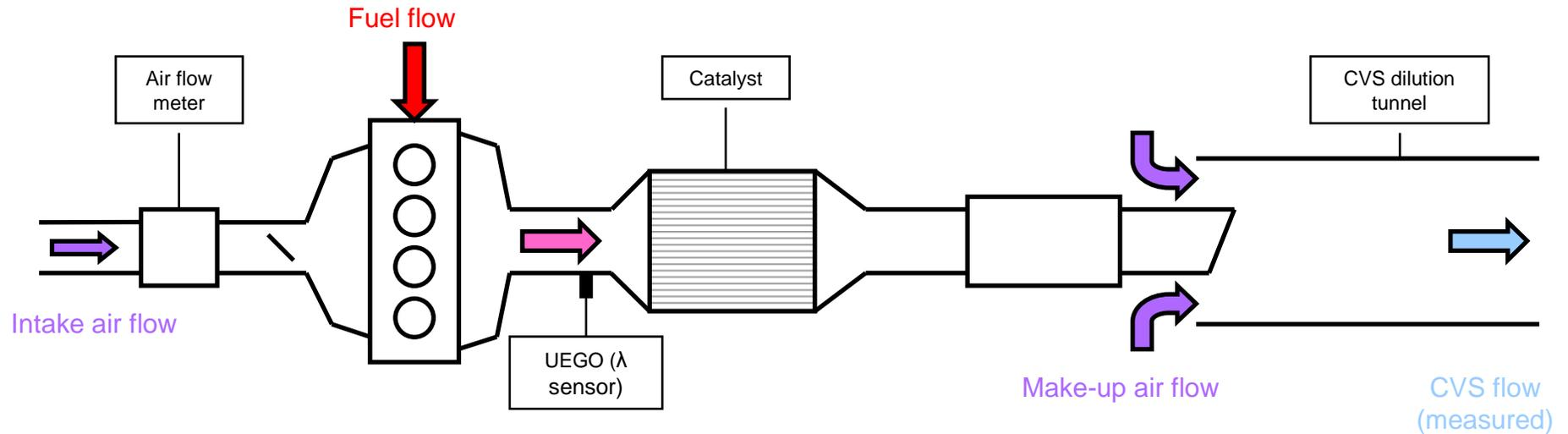

To make correct measurements, exhaust flow rate should be calculated at similar response time to the measured pollutant values.

For fast FID:

- Air Flow from engine air meter is preferred (fast measurement)
- Fuel flow = mass air flow / (λ x stoichiometric air-fuel ratio)

Schematic diagram of HC mass calculation

- Illustration of calculation of HC mass – FTP cycle

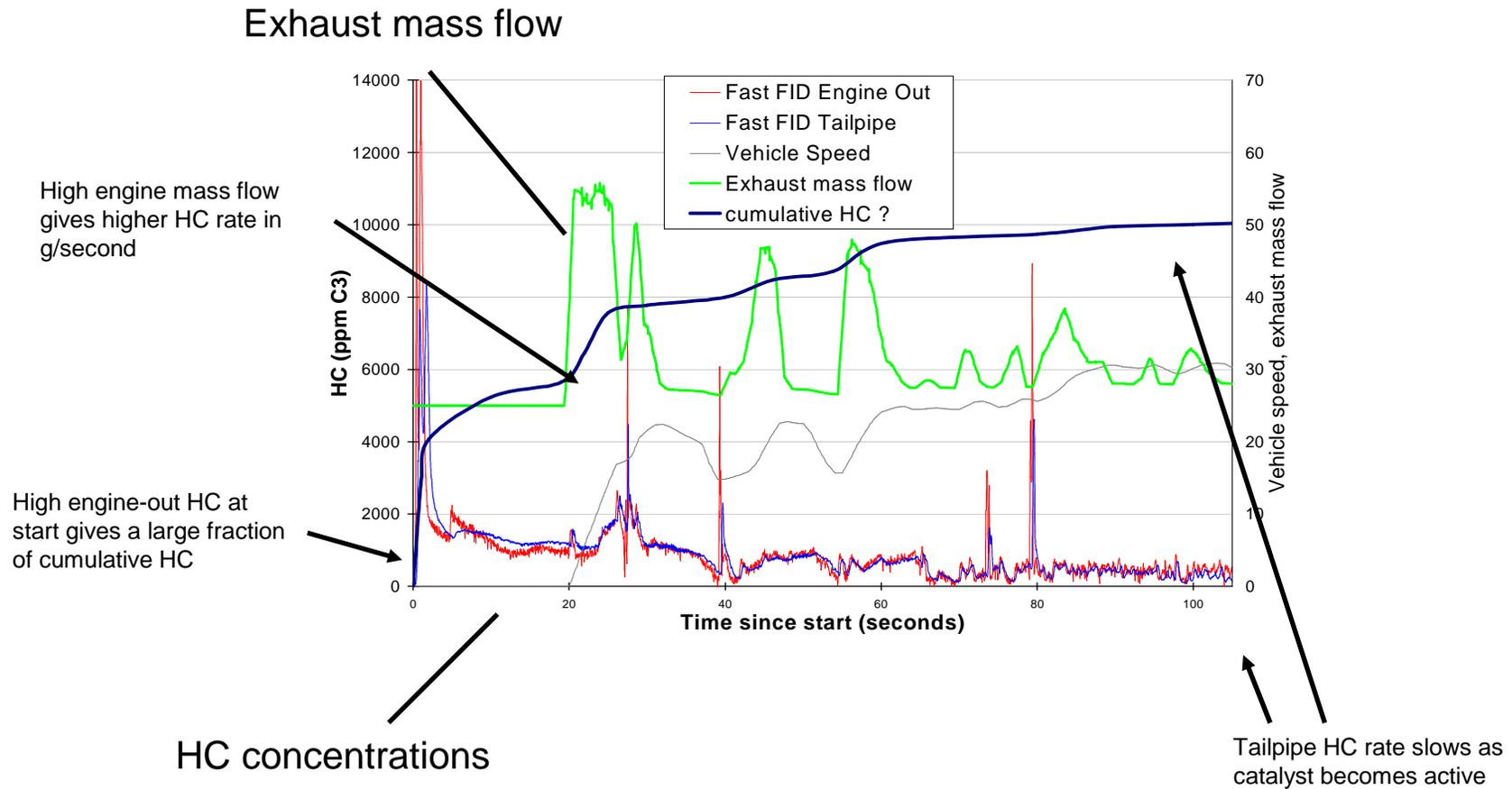

Emissions analysis – HC mass flow calculation

- Calculation of HC mass flow rate

- Mass flow rate of HC is:

Exhaust mass flow rate x (ppm HC / 1,000,000) x $\frac{\text{molar mass [HC]}}{\text{molar mass exhaust}}$

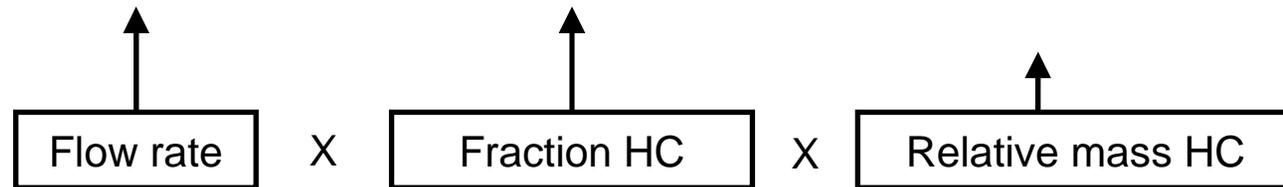

- Molar mass of exhaust ~ 29 – varies slightly with fuel
- Molar mass HC is defined in legislation, for European gasoline regulations for C1:
 - Stage 4 fuel molar mass for THC = 13.86, assumes C:H 1:1.86 in exhaust
 - Stage 5 fuel molar mass for THC = 13.93, assumes C:H 1:1.93 in exhaust

Wet/ dry measurement compensation for cold-start

Effect of catalyst on exhaust gas water content

- Catalyst has extremely large surface area
 - Water will condense on any surface cooler than the 'dew point'
 - For stoichiometric exhaust gas, dew point is 55°C

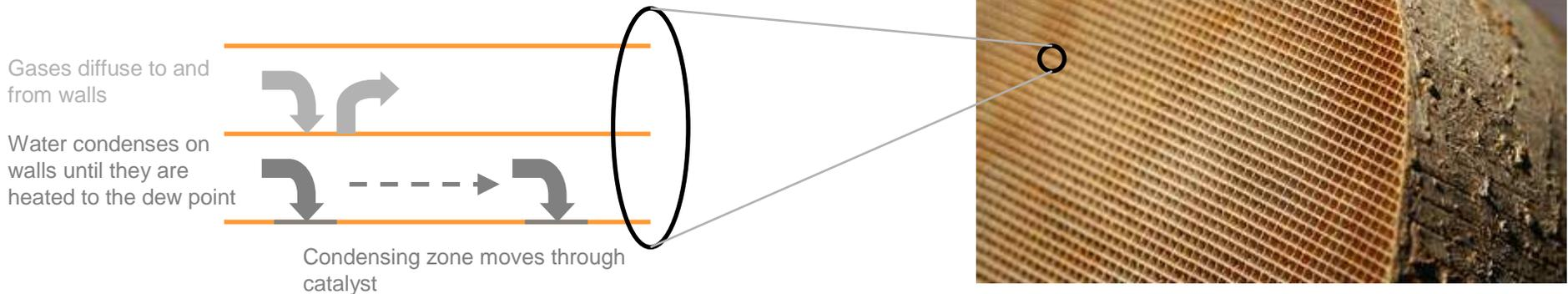

- As the catalyst temperature rises to 55°C from the front, the condensation point moves through the brick
- Therefore, the water content at the catalyst **exit** is ~12% lower than the inlet until the exit of the catalyst is > 55°C (Gas conc is therefore 13% higher)
- To correspond with CVS measurements, the exhaust concentration measurement needs to be reduced by ~12% until the water stops condensing (determined by thermocouple at catalyst exit)
- The re-evaporation of the water occurs over a generally longer time-scale and the errors associated with the increased flow at catalyst exit are negligible.

Emissions analysis – Mass HC processing

- Create Excel workbook
- Calculate exhaust mass flow
- Calculate mass flow rate of HC
- Make water correction
- Integrate mass flow of HC into g

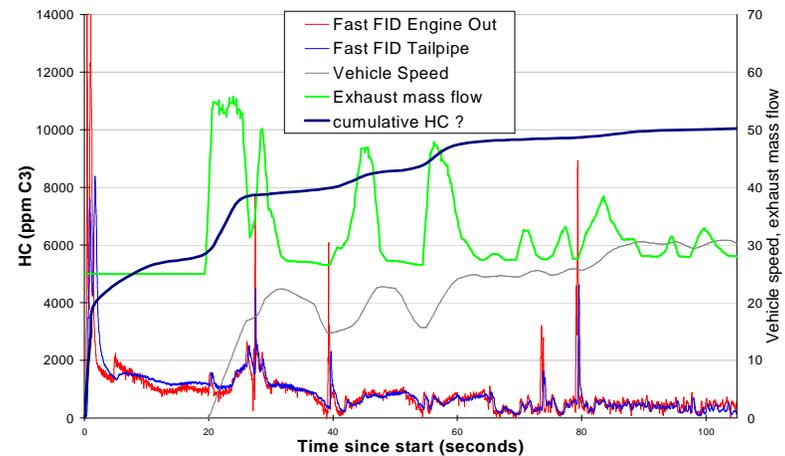

Case study – Cold start and NEDC on 4 cyl 2.0l PFI engine

Now that we have covered the theory we can

- Examine raw HC data for general information
- Determine exhaust gas flow
- Time alignment of data
- Calculate 'engine out' HC flow rate (g/s)
- Calculate catalyst out HC flow rate (g/s)
- Integrated (modal) mass to quantify the contribution of individual events to cycle total
- Use this information, together with the HC concentrations, to diagnose problem areas
- Use information from other sensors and ECU parameters to find the cause of the events

Case study – Transient HC features on raw data vs time

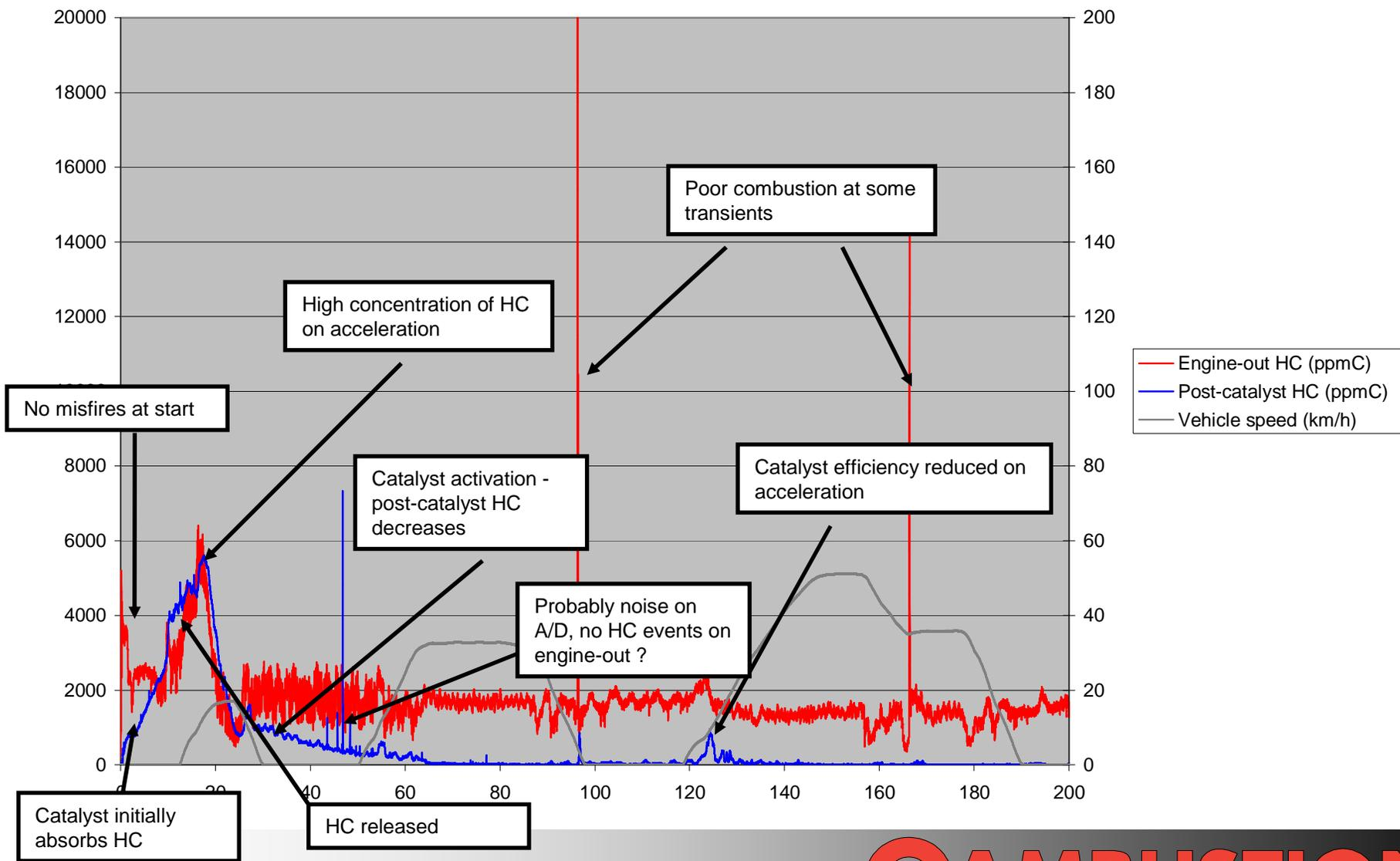

Case study - Determine exhaust mass flow

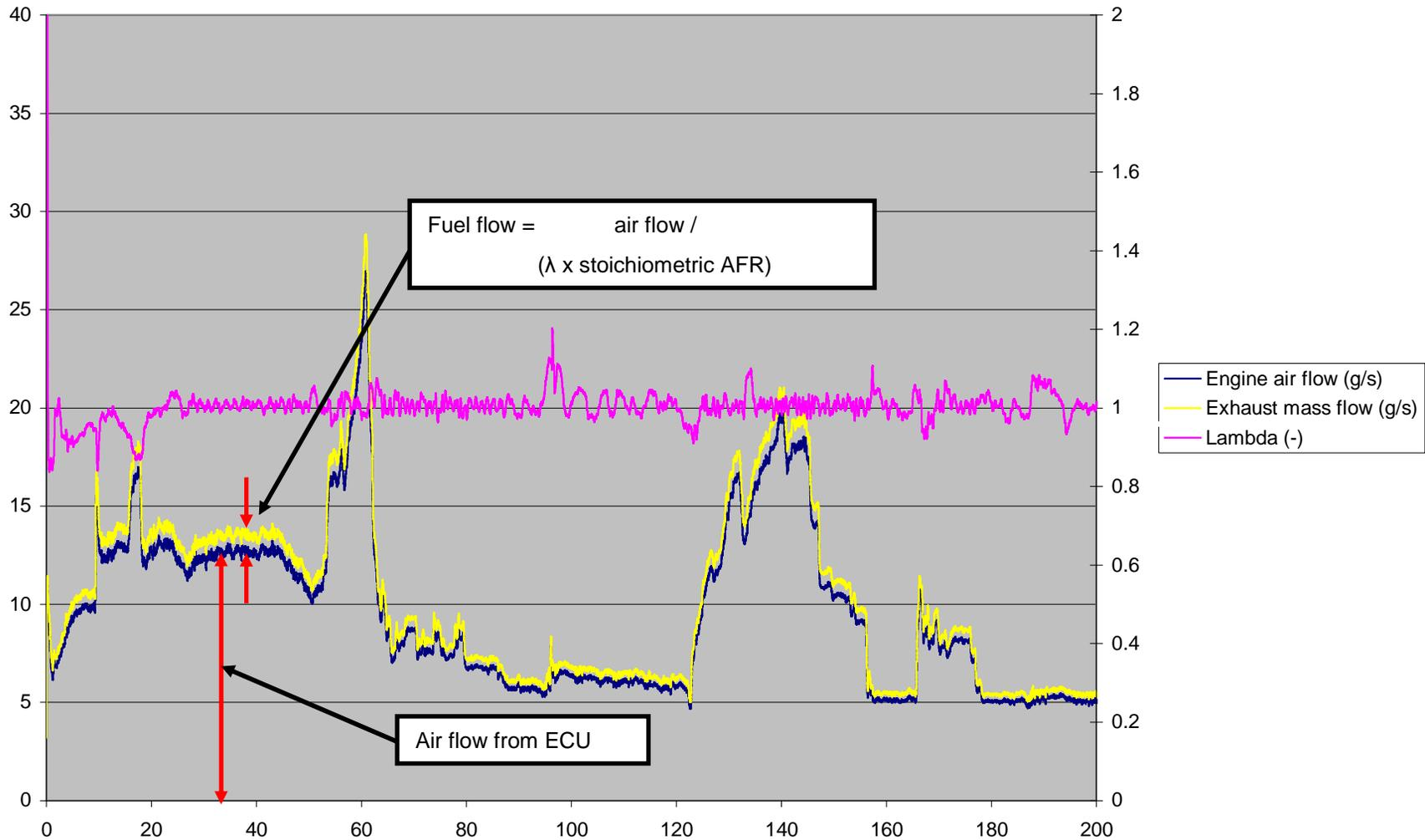

Case study – Time alignment/ datalogging

- Exhaust flow rate and HC concentrations both change rapidly
 - It is important that the analyser is fast enough to resolve the changes in HC
 - If the mass flow is not measured accurately this will cause errors
 - If there is a time delay between the mass and HC measurement, the result will be wrong!
- Important if different data sources used
 - For example ECU data and A/D system
- Logging frequency must match
 - To avoid time alignment errors

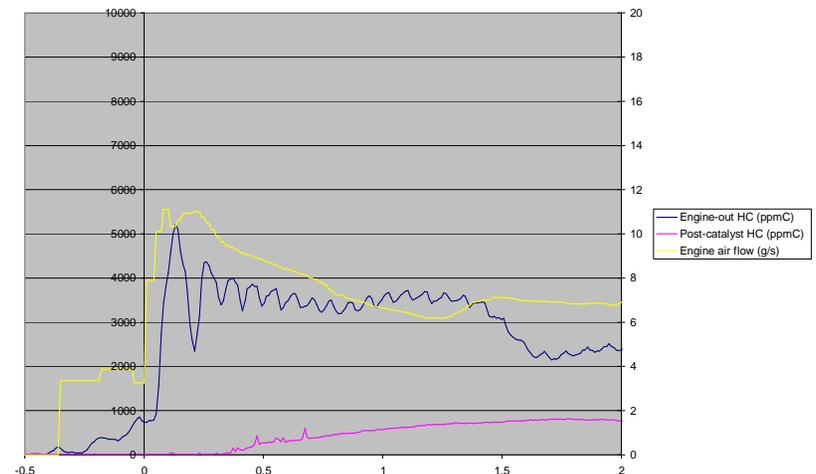

Case study – Engine-out HC flow rate (g/s)

- Multiply HC fraction of exhaust by exhaust flow rate
 - Make sure the units are correct
 - Convenient to have mass flow in g/s
 - HC is in ppm (C1), so divide by 1,000,000
- But HC molecular weight is not the same
 - Exhaust gas approximately 29g/mol
 - FID counts carbon atoms (C1 or C3)
 - Legislation decides how much H₂ to add
 - C1 is 13.86 g/mol for Stage 4
- Therefore multiply result by 13.86/29
 - $3 \times 13.86 / 29$ if data is ppm C3

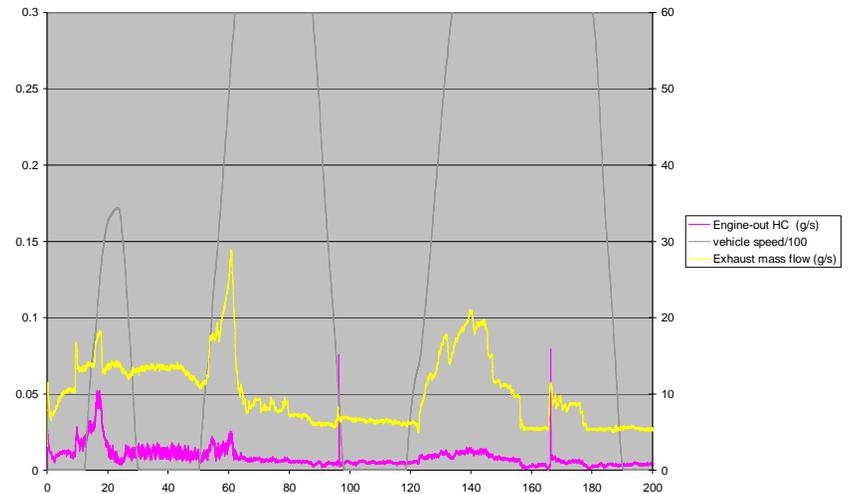

Case study – Post catalyst HC flow rate (wet/ dry correction)

- Mass flow is correct for 'wet' ppm
 - When gas is dried, ppm will indicate higher
 - For stoichiometric exhaust, approx 12.5% water
 - Reduce ppm value by 12.5%
 - This will convert to approx 'wet' value
- When catalyst stops drying
 - Correction no longer needed
 - Indicated by temperature > 55 °C
 - In this case, around 15 seconds from start
- More accurate equations can be used
 - But effects are small
- Same equation as for engine-out

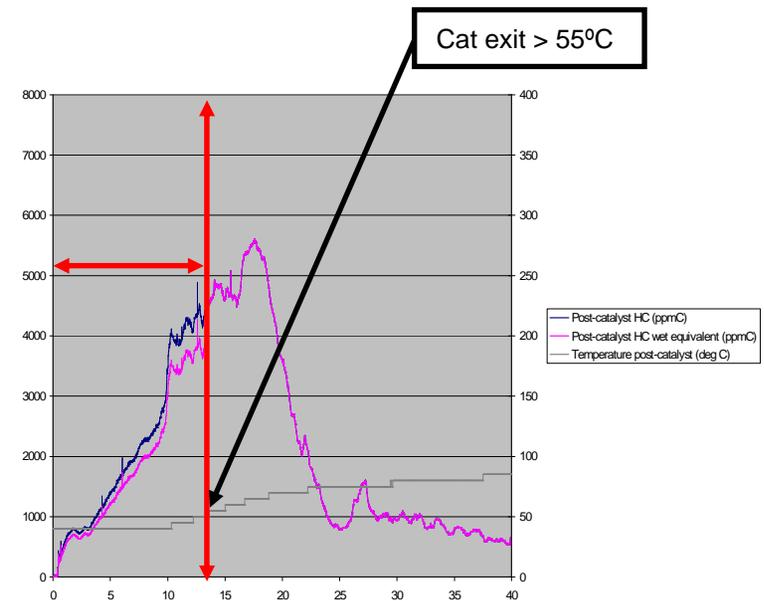

Case study – Integrated (modal) HC emissions

- Engine out and post-catalyst:
- For each data point
 - Add g/s value x time per point (dT) to previous value
 - If CVS emissions available, may be used for cross-check on post-catalyst HC

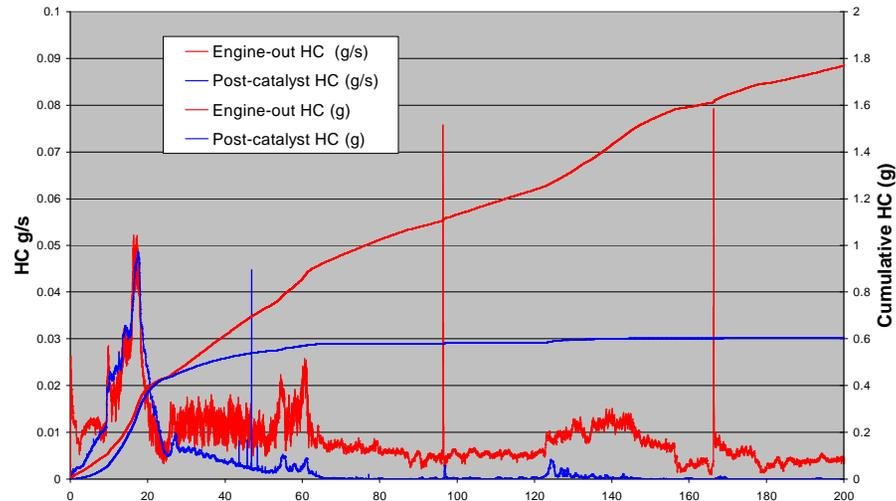

Interpretation of data - Overview

- Now we have HC data in g/s and g
 - Individual events and features can be examined
 - FID will help to understand the processes (ppm)
 - Mass data will identify the contribution to cycle HC emissions
- Engine-out HC can clearly be associated with transient events
 - Real-time HC data allows accurate analysis
- What can we see in the example data set ?
 - Calibration was for test purposes only !
 - Identify high g/s portions
 - are they caused by high HC ?
 - or by high exhaust mass flow

Interpretation of data – General observations

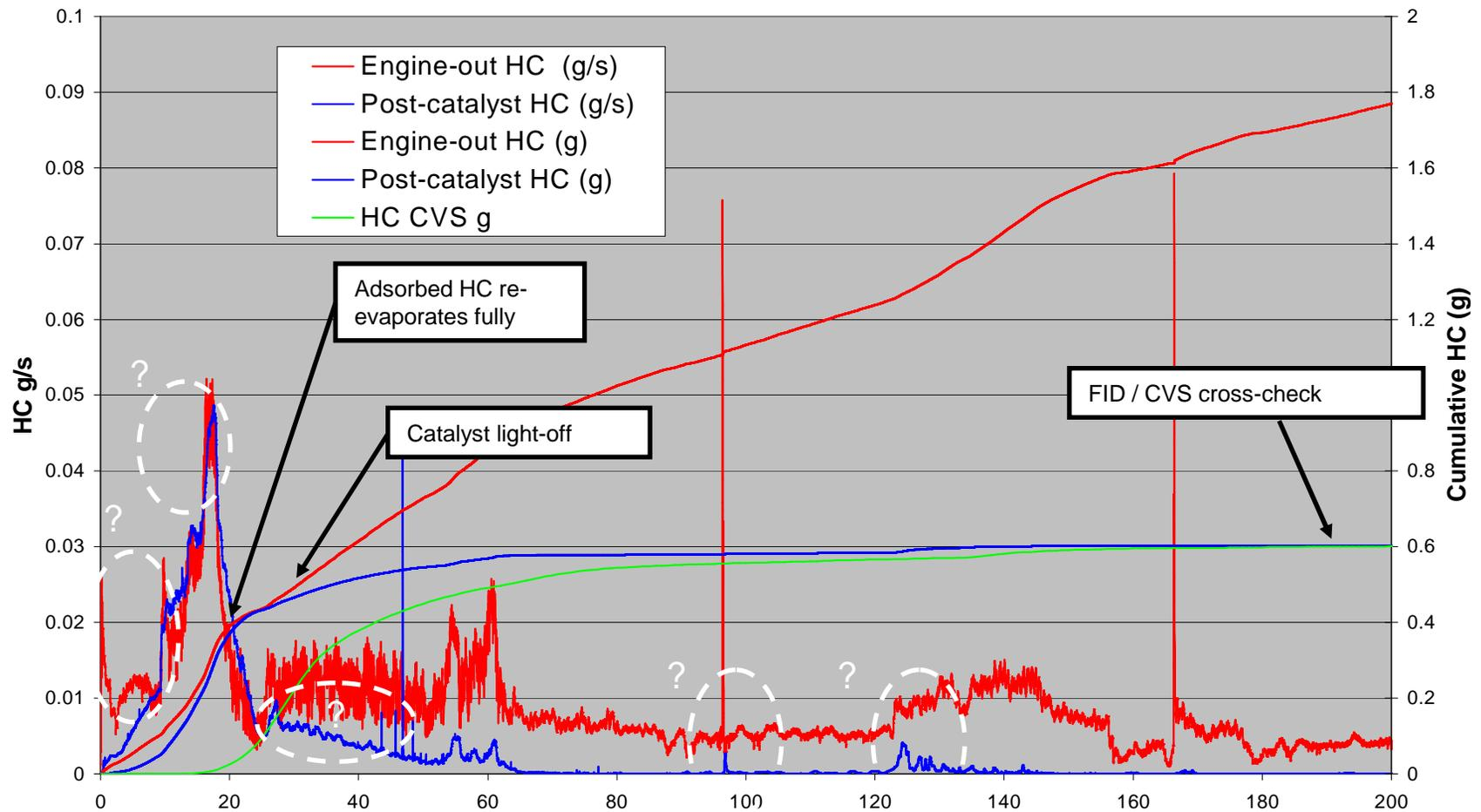

Interpretation of data – significant features

- We can see obvious features:
 - Catalyst HC absorption / desorption
 - Catalyst light-off
 - CVS emissions (second-by-second / bag) agree with Fast FID/ exhaust mass integration
 - Typical accuracy +/- 5%

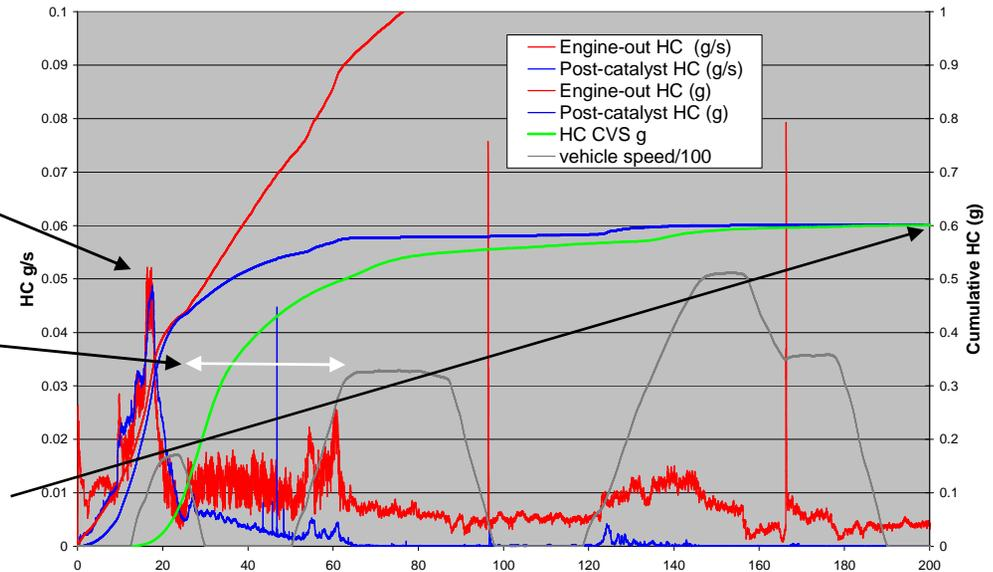

- We can prioritise events using the g HC they cause
 - Concentrate on **engine-out HC** when catalyst is inactive
- But there are more features we need to investigate to find the reasons
 - Add other data from ECU
 - Lambda sensor
 - Temperature measurements

Interpretation of data – Before catalyst light-off

Approximately 60% of cycle HC emissions in 25 seconds

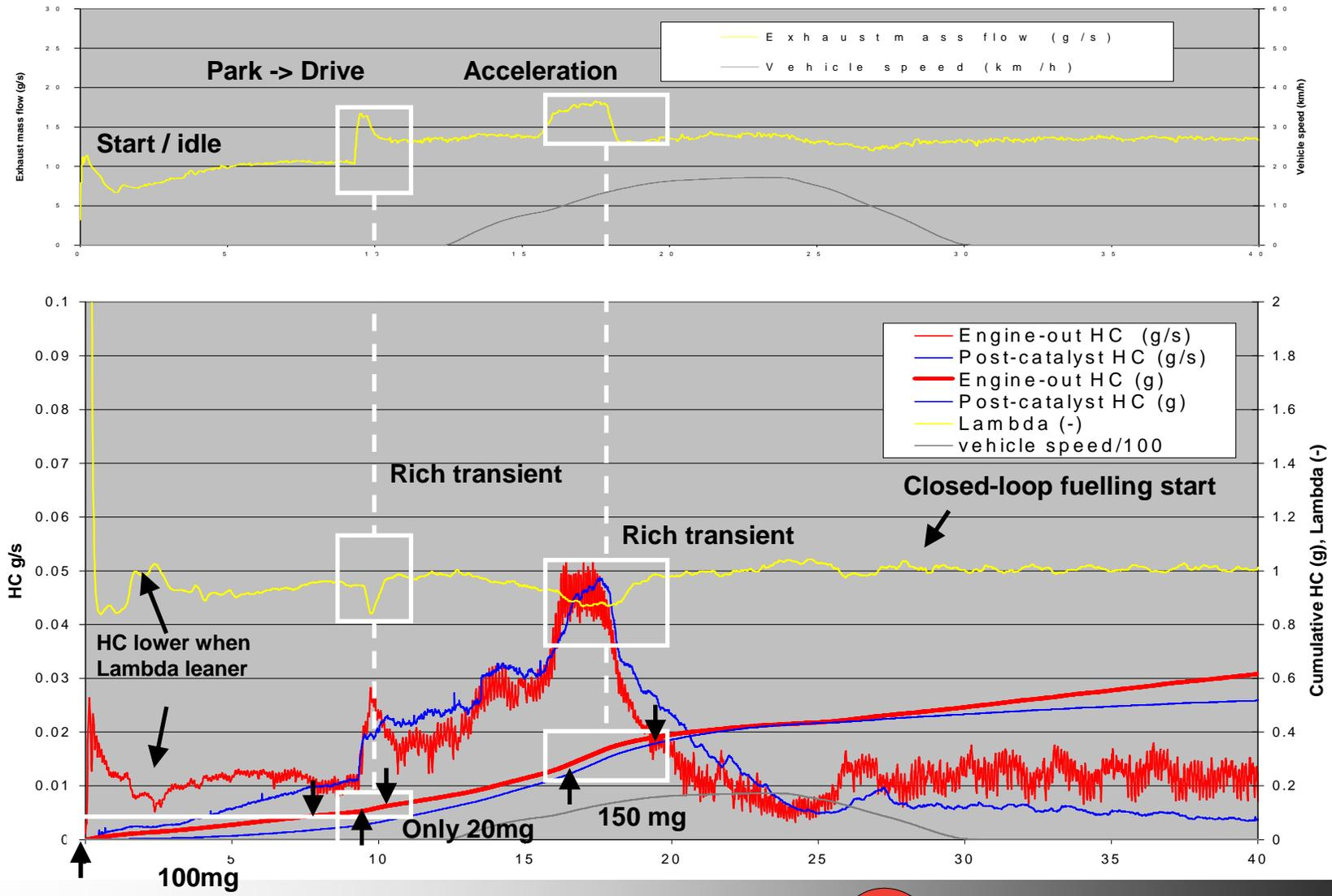

Interpretation of data – Phase 1

Can begin to look at post-catalyst HC once catalyst is active

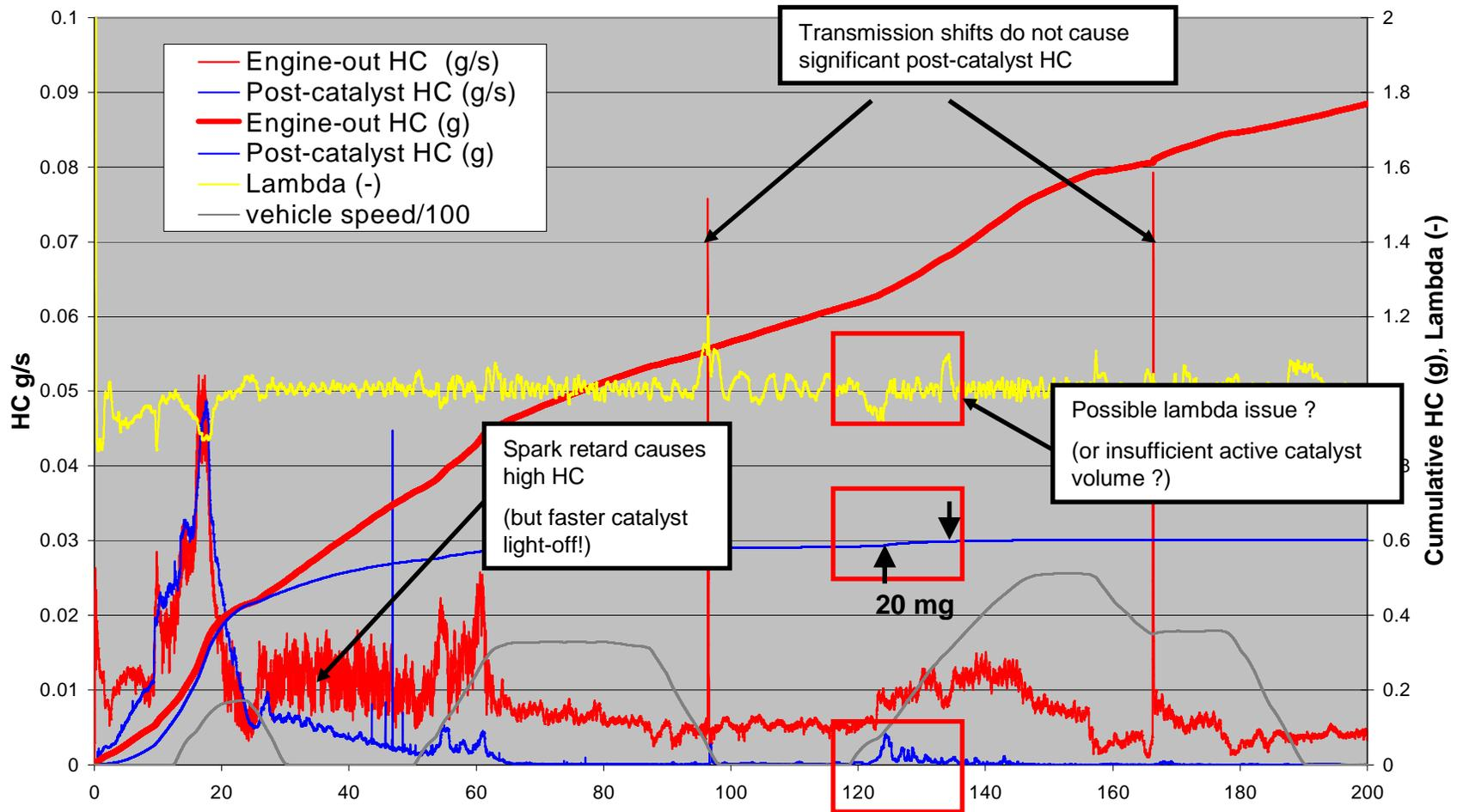

Interpretation of data – Strategy for HC reduction

- Principles are easy to understand:
 - Use fast HC data to find the large contributions to cycle total
 - ‘Zoom in’ on these areas to examine closely
 - Use HC information and other signals to understand the cause
- Calibration engineers can then decide what to change
 - Subject to constraints and project targets

Catalyst warm-up – Light-off process/ Location

- How does the catalyst light off ?
 - Catalyst inlet temperature must be hot enough to activate the catalyst
 - Exhaust flow convects the heat through the catalyst
 - Once the front of the catalyst is hot enough to become active, the volume of active catalyst increases
 - After the catalyst becomes active, additional heat is generated by exothermic reactions
 - It is beneficial to have the catalyst active from the earliest possible time, to minimise emissions and take advantage of exotherm
 - High exhaust flow can cause 'breakthrough' of emissions
- Location – close coupled/ under body
 - The above can affect the packaging – the nearer to the exhaust valve the better (Beware... may become too hot at high load)

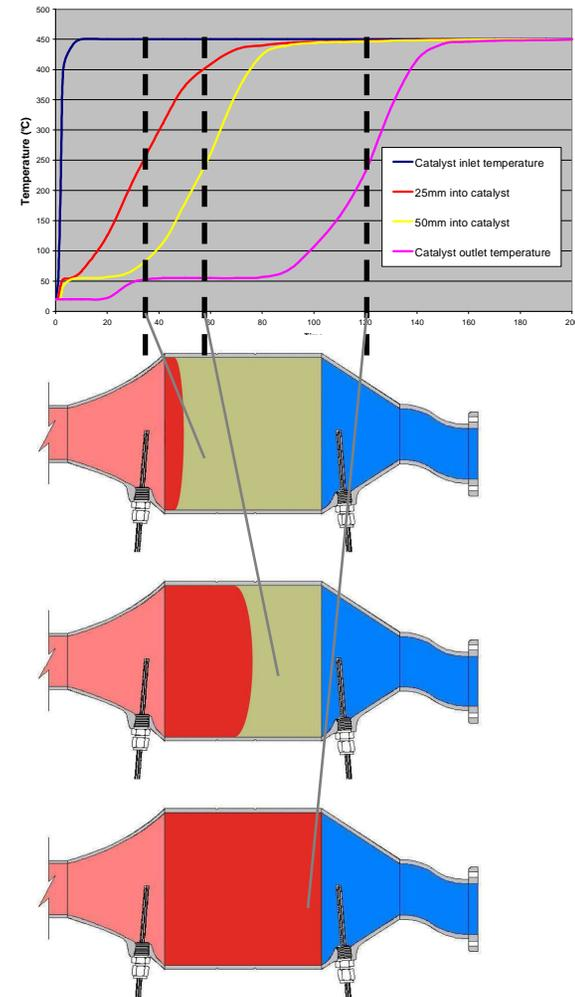

Catalyst warm-up – Drive-cycle effect

Influence of drive cycle on catalyst light-off and emissions

- What is the objective ? – sufficient volume of **active** catalyst as soon as possible
- We have seen that the energy flow to the catalyst is controlled by the **inlet temperature** and **exhaust mass flow**
- Catalyst heating is therefore influenced by the drive cycle
- Inlet temperature and mass flow both increase with engine load, when the vehicle is accelerating

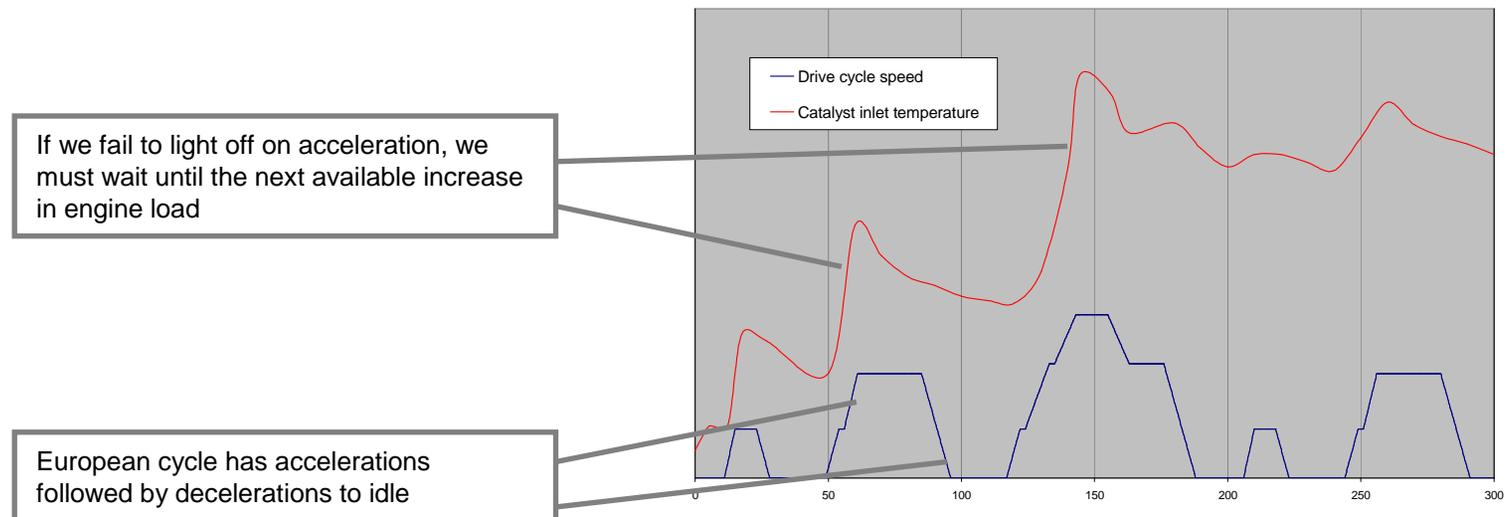

Catalyst warm-up – Exhaust flow effect

- The importance of exhaust mass flow
 - Strongly affects catalyst temperature
 - Exhaust manifold walls are ‘cold’ for this phase, large temperature difference between gas and pipe
 - Temperature loss between engine and catalyst is reduced at higher mass flows
 - Speed of heating of catalyst (energy flow) is proportional to mass flow

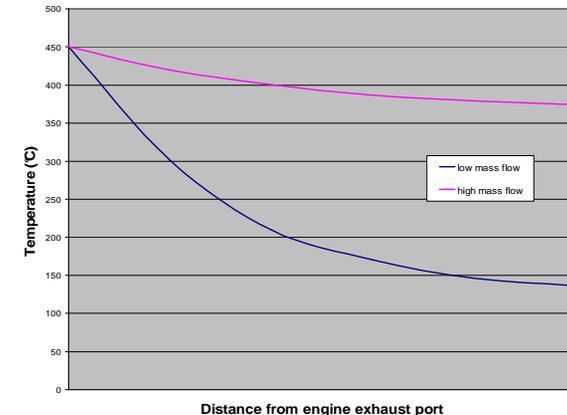

- Some other cautions
 - Cautions regarding exhaust gas oxygen sensors (especially cranking / misfire)
 - Large amount of unburned reactants mean the UEGO sensor is unable to fully react all the fuel and air – result will indicate leaner than actual lambda value
 - Cautions regarding measurement of gases pre-catalyst if backflow is possible
 - Retarded spark (for catalyst heating) can cause exhaust flow to reverse for part of the engine cycle due to pressure fluctuations
 - Sampling near to the inlet face of an active catalyst can cause HC reading to be lower than engine-out
 - UEGO sensors and heated probes can heat the exhaust system (and affect the cold start)
 - Switch on as late as possible !

Cold start optimisation principles – Important phases

- Decision of which phases of the cycle to concentrate on

• Catalyst state: Inactive → Fully active

• Engine temperature: Cold → Hot

• Engine state:

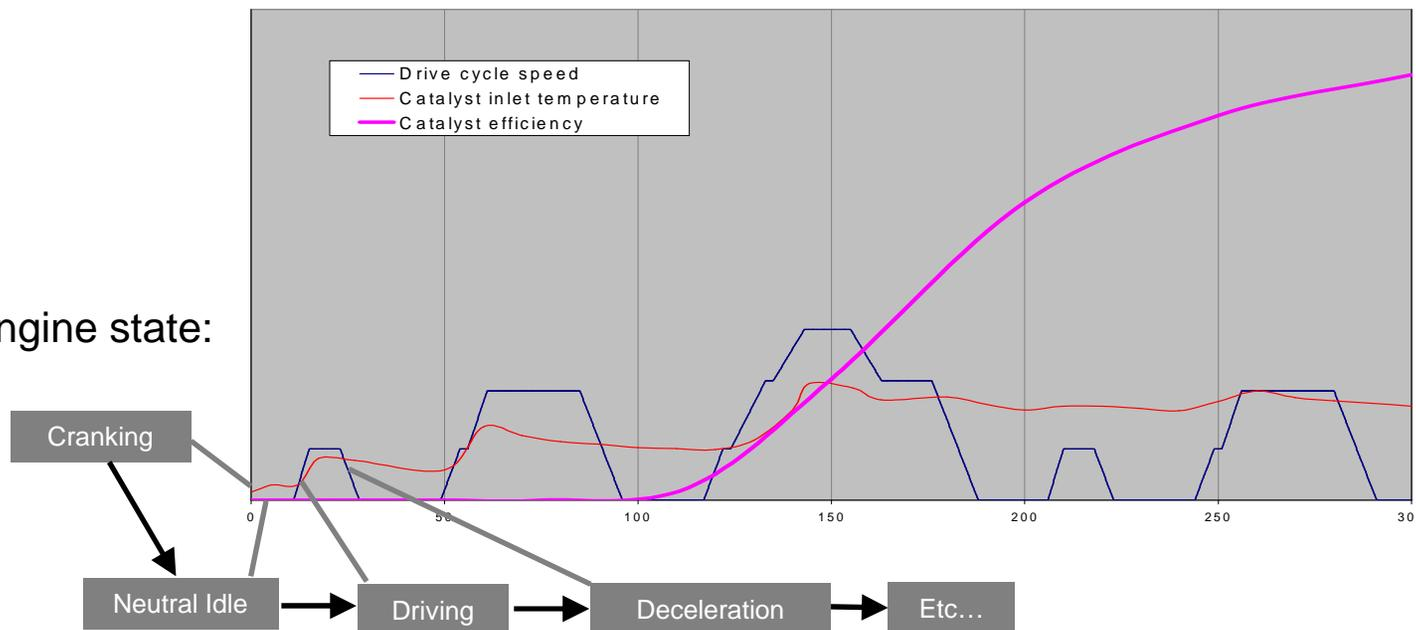

Cold start optimisation principles – Catalyst light-off

- Assess relative contributions to HC for each area, concentrate on area where catalyst is inactive !

- Catalyst state: 

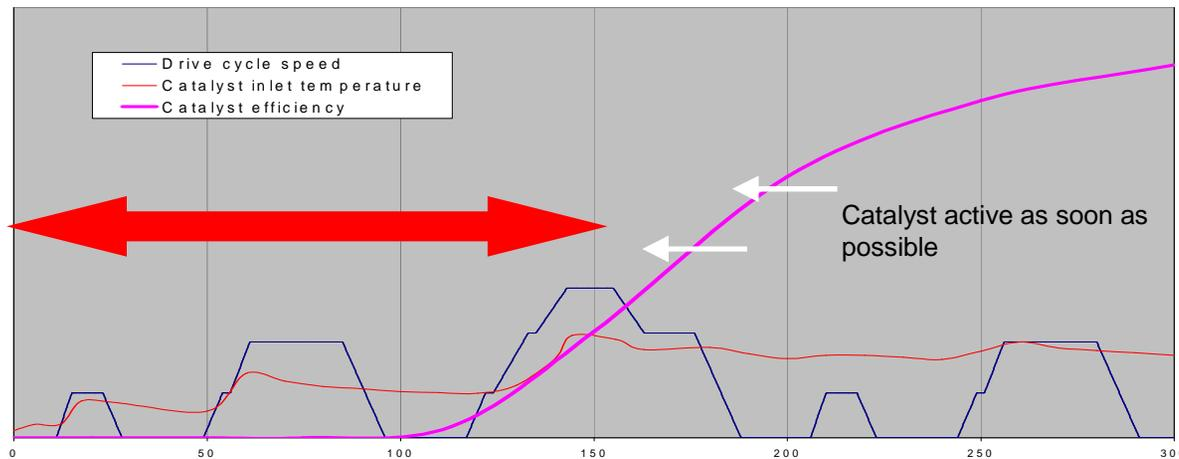

Optimising the warmed-up phase is for future presentation
NB Fine lambda control (0.001 λ) affects CO, NOx ...



- Fuelling control state:



Opportunities to improve calibration – variables/ actuators

- Engine actuators – example engine

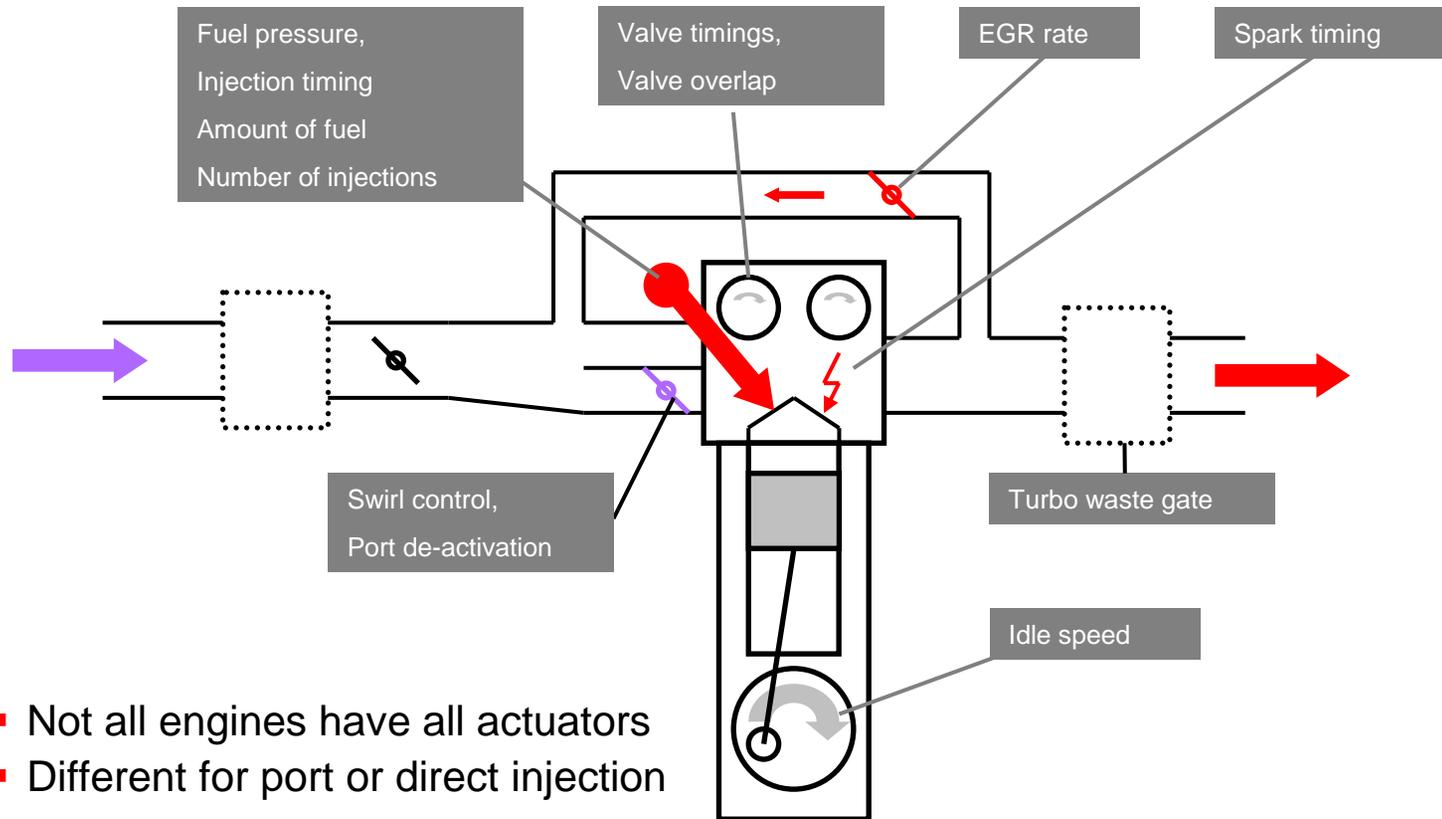

- Not all engines have all actuators
- Different for port or direct injection

NB – ensure that 'adaptive' parts of strategy are not active during calibration
(fuel injectors and air flow meter)

Opportunities to improve calibration – Spark timing

- Actuators that can be adjusted
- Spark timing
 - Key parameter for engine combustion
 - Later spark means less torque, **higher exhaust port temperature**
 - Less torque per unit fuel means **higher exhaust mass flow** for same torque
 - Higher exhaust port temperatures can oxidise HC and CO to **reduce engine-out pollutants**
 - **Be careful – higher mass flow means engine-out HC concentration must be reduced to avoid increasing HC mass (g)**

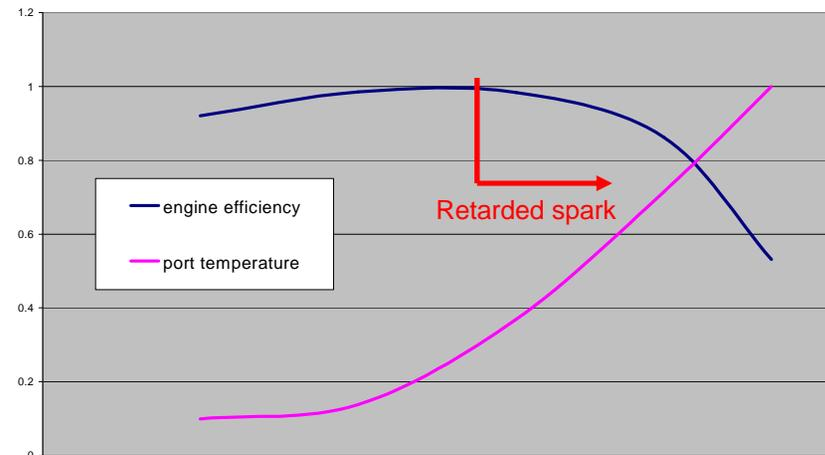

- Retarded spark timing can improve engine-out HC, but may cause combustion instability
 - May result in misfire or unacceptable idle
 - Less efficient use of fuel increases fuel consumption

Opportunities to improve calibration – Fuelling/ injection

- Actuators that can be adjusted
- Fuelling control
 - **Air-fuel ratio** is key for **combustion**
 - Ignition is affected by vaporised fuel only
 - **Lambda** (λ) is important for engine-out HC, CO, NO_x and **catalyst performance**
 - Exhaust port reactions are strongly affected by λ
- Injection timing & number of injections
 - What to do before ECU has synchronised (found crank position and stroke information) ?
 - Inject onto open or closed valve ?
 - Multiple injections may be possible with direct injection engines
 - Some fuel injected early to vapourise, some fuel injected late to provide rich region at spark

Opportunities to improve calibration – Valve timing

Actuator that can be adjusted:

- Valve timing
 - Usually large valve overlap is detrimental to emissions performance
 - During cold start it is possible that the back-flow from exhaust to inlet is **helpful**
 - Backflow heats up inlet valve and inlet port
 - Helps to vaporise fuel

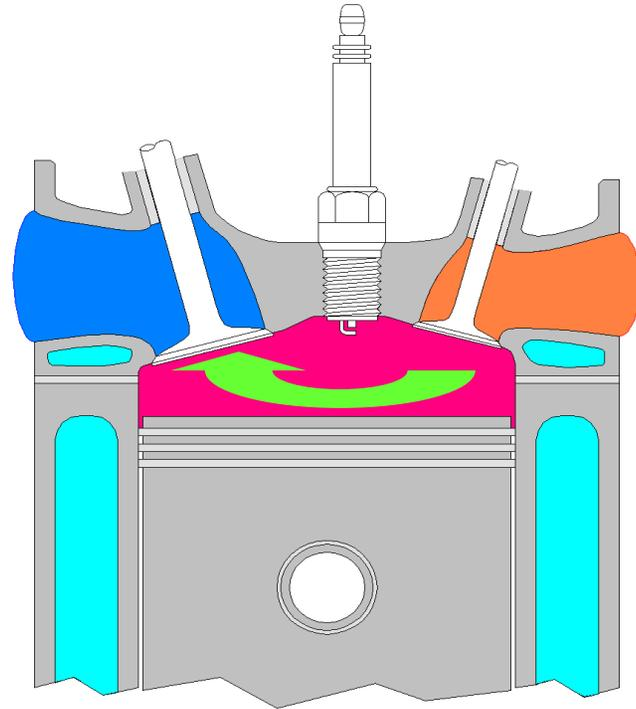

Opportunities to improve calibration – Other possibilities

Actuators that can be adjusted:

- Inlet port de-activation (swirl control)
 - Controls mixture motion in cylinder
 - Affects combustion, emissions and optimum spark timing (MBT)
- External EGR
 - Not usually useful in crank & idle ?
- Turbo setting
 - Opening waste-gate may reduce heat loss of exhaust gas
- Others...

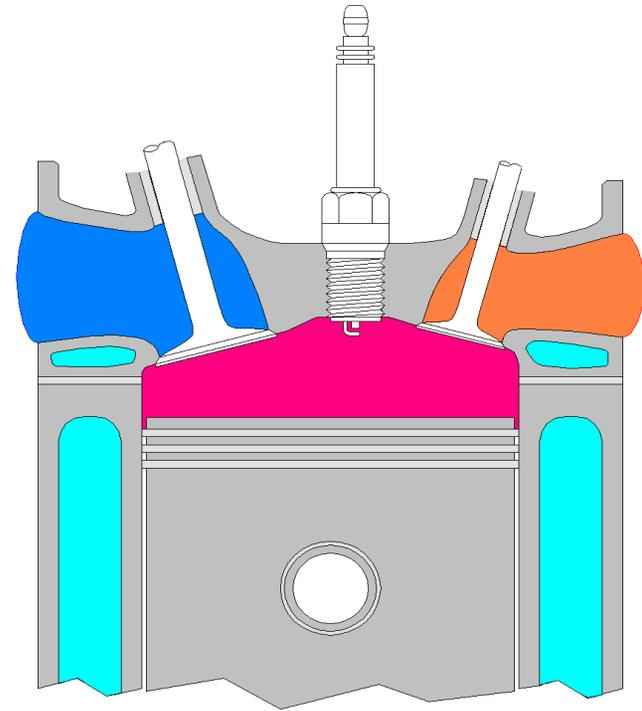

Important factors for calibration development

Catalyst condition – representative of mid-life vehicle condition ?

- 'Optimal' calibration depends on catalyst !

Repeatability - vehicle and the drive cycle should be repeatable as possible

- We can then make valid comparisons between calibrations
 - Engine and transmission temperature – additional cooling for short soak times
 - Catalyst temperature – may also need additional cooling
 - Driver repeatability (robot ??)
 - Battery charge state – important for cranking repeatability and alternator load
 - Vehicle must be run until fully warmed up each time to ensure inlet manifold conditions are repeatable
 - Fuel specification

Record keeping, file archiving

- Record all calibration changes
- Engine coolant temperature at start
- Environmental conditions: temperature, pressure, humidity
- Record any changes to vehicle, engine, exhaust system

Opportunities to improve calibration – ECU strategy overview

- ECU strategy and parameter maps

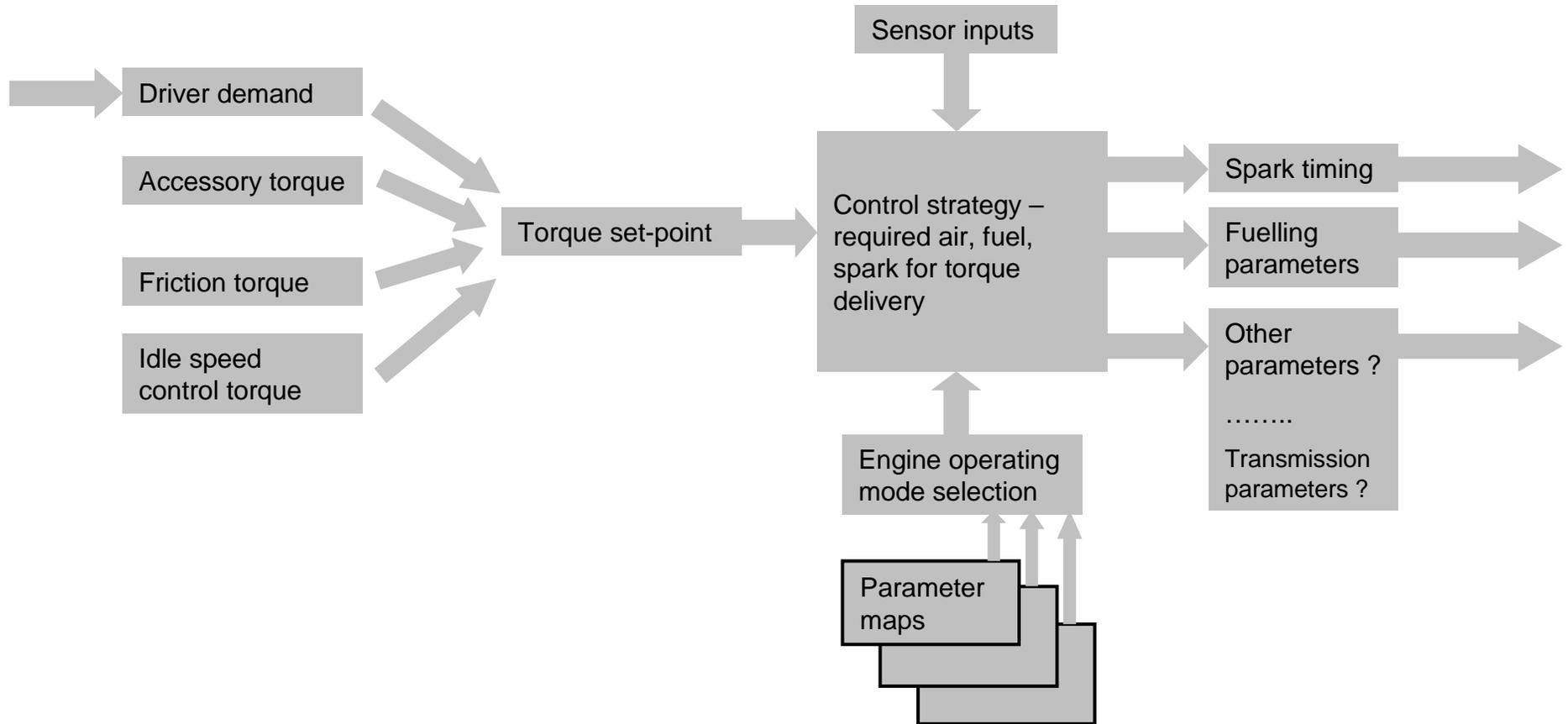

Opportunities to improve calibration – Generic operation modes

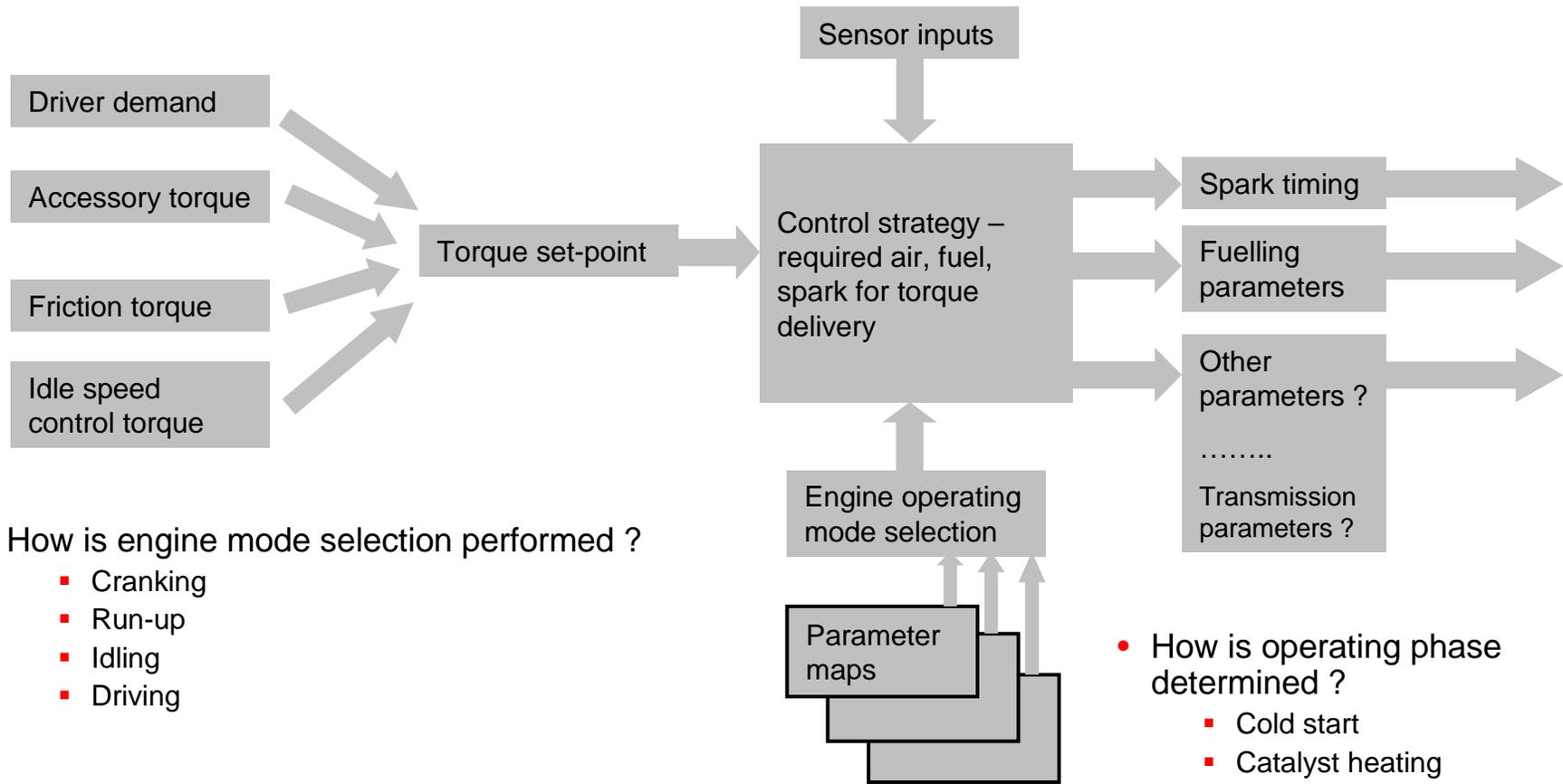

- How is engine mode selection performed ?
 - Cranking
 - Run-up
 - Idling
 - Driving

- How is operating phase determined ?
 - Cold start
 - Catalyst heating
 - 'Closed loop' fuel control

Opportunities to improve calibration – Maps/ primary variables

- Identify map axes, primary variables for control
 - Usually engine torque (load) and engine speed
- Identify parameter maps for:
 - Idle speed selection in catalyst heating and idle modes
 - Adjusts mass flow (higher speed = higher mass flow)
 - May also affect combustion quality
 - Charge (air) control & spark timing
 - Will be different in different operating modes ?
 - Engine fuelling
 - Initially should be lean of stoichiometric ($\lambda > 1.00$) to minimise HC, CO from combustion
 - NOx is usually less important during cold start phase
 - What controls fuelling when oxygen sensor is cold (inactive) ?
 - What controls fuelling compensation for transients ?
 - Control parameters for catalyst heating
 - Spark timing controlled in catalyst heating mode
 - What condition terminates catalyst heating (model) ?
 - Other actuators
 - Valve timing,
 - Intake port deactivation
 - ?

Opportunities to improve calibration – Limitations

- Limitations on calibration values

- Customer acceptance

- What are customer expectations of idle quality, noise, vibration ?

- Combustion

- Spark timing cannot be retarded indefinitely
 - Misfire will cause unacceptable idle / drive quality and increase in emissions

- External requirements

- Spark retard causes increased inlet manifold pressure to provide the increased air flow
 - This reduces available vacuum for brake servo
 - Maximum idle speed may be limited for auto transmission due to 'creep'
 - Is fuel economy satisfactory ?

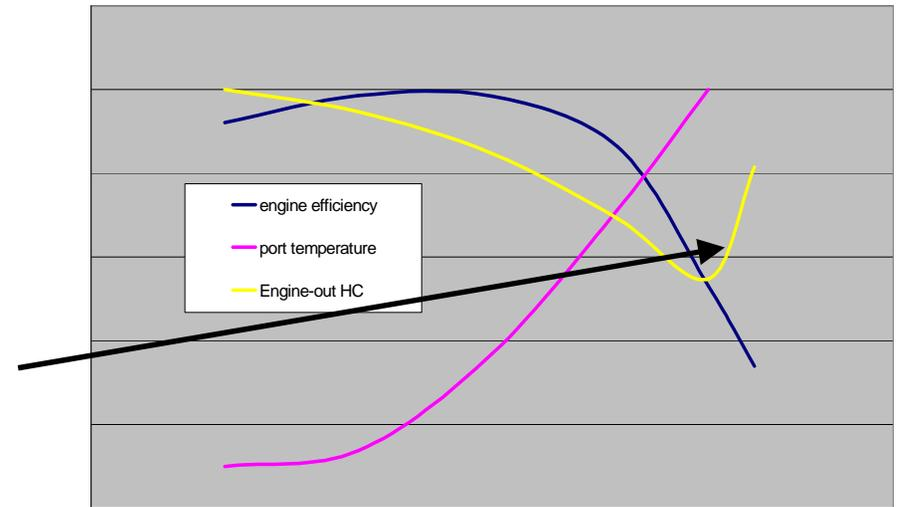

Opportunities to improve calibration – Limitations

- Limitations on calibration values
 - Actuator limitations
 - Valve timing may be fixed until oil pressure is high enough to allow movement
 - EGR system and turbo waste gate may be operated by vacuum
 - Cranking fuel pressure may be limited, especially for direct injection engines

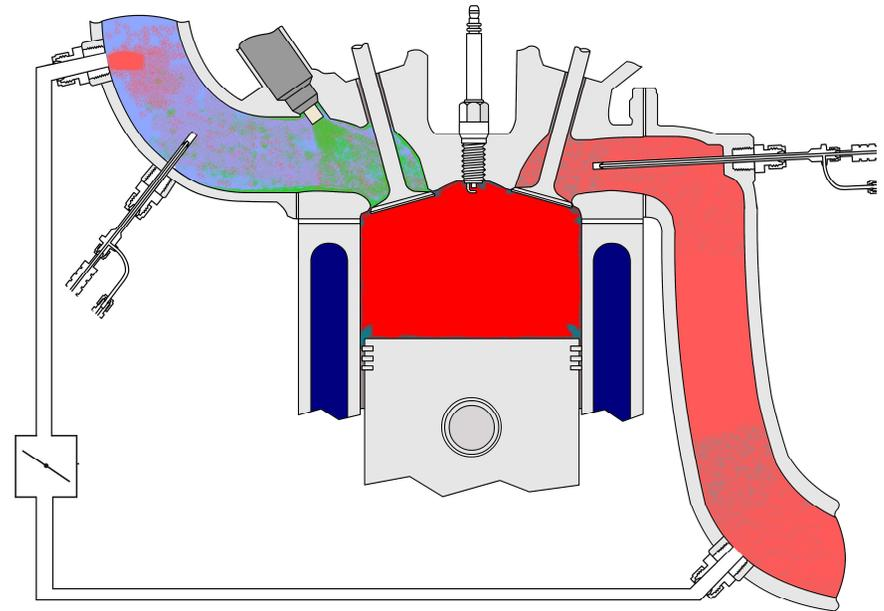

Opportunities to improve calibration – Limitations

- Limitations on calibration values - continued
 - What else can go wrong ?
 - Unexpected things, for example exhaust valve leakage
 - Case study example SAE 971638
 - Can cause high HC emissions
 - Identifiable using fast FID but.....
 - Mass flow integration is not accurate in this location as the mass flow is intermittent and pulsating, and cannot be accurately time-aligned with the FID signals

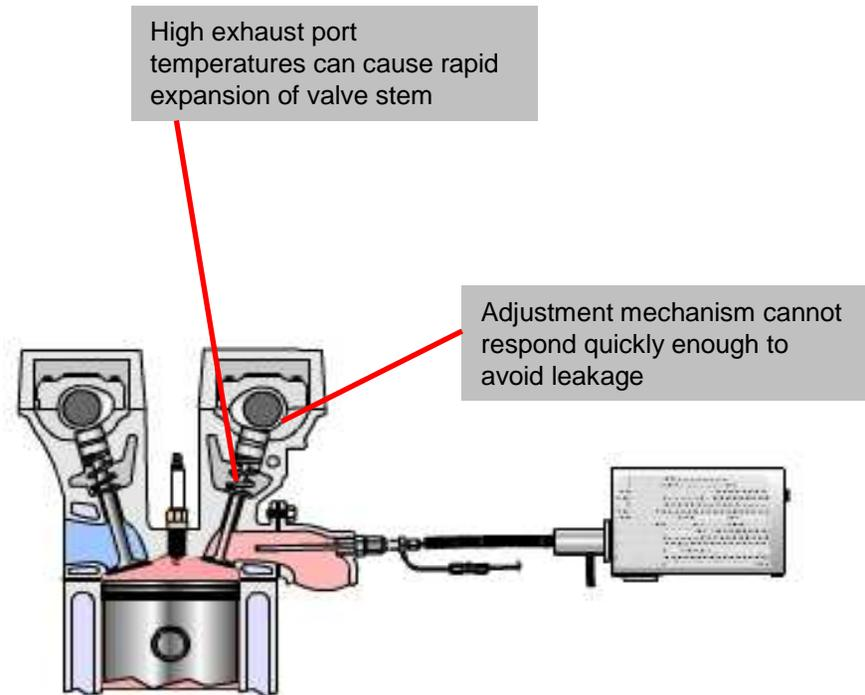

Opportunities to improve calibration – tolerance/ variability

- Introduction to testing high and low tolerance envelope

- We must be careful to avoid settings that are too close to stability limits
 - The engine may stop in different position each time, this will affect when the control system becomes synchronised next time the engine is started, and affect the crank / start
 - Normally we should perform several tests to see if the engine behaves repeatably
 - Usually worst variation in lambda is at the crank/ start
- We must allow for the vehicle tolerance envelope (sensor variability, measurement error etc)
- Variations in components (especially fuel injectors) can cause large variations between different vehicles
- Lean and rich limit examples should be tested....

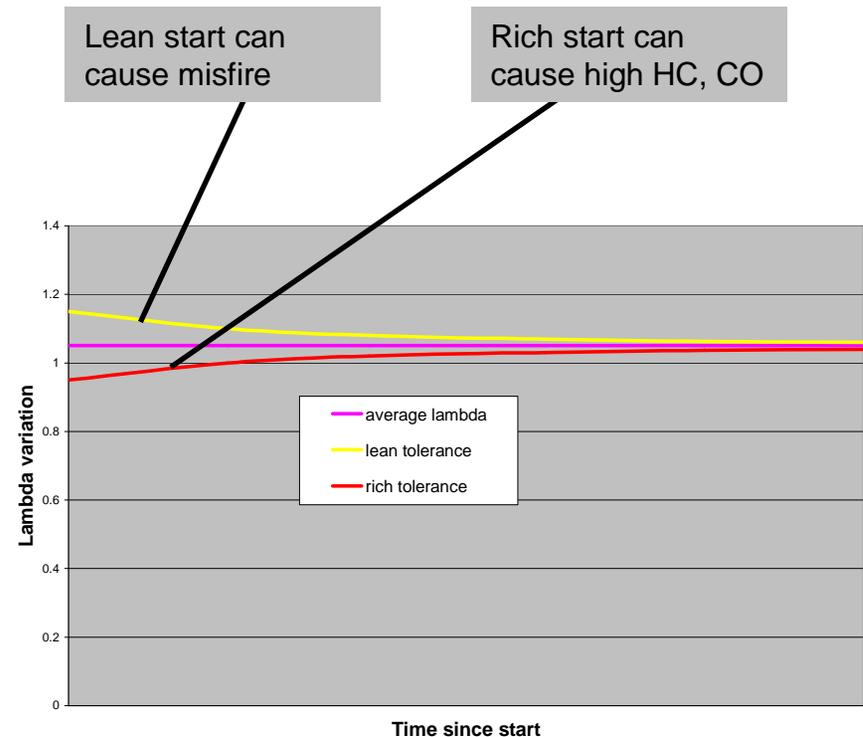

Conclusions

- We have covered the theory & practice of cold-start study using fast FID
 - To measure the HC produced by the engine
 - To study the effect of calibration on engine-out and tailpipe HC
- Fast HC analysers are a useful tool
 - Help to identify problem areas
 - Help to determine the cause of emissions problems
 - Cold- start calibration without the use of a CVS facility is demonstrated